

A-PROBE
EliteControl
(place beside driveway - 10 - 100m from gate motor)

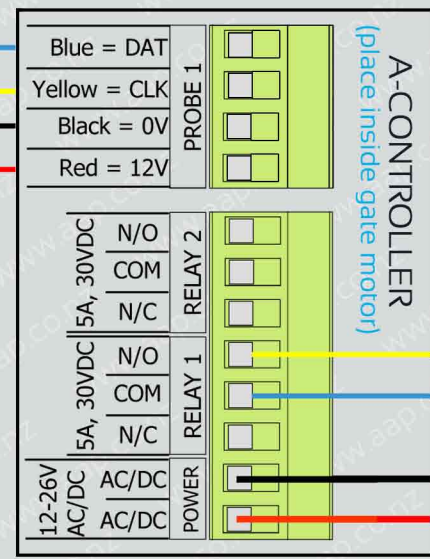

Note: The OPEN/PED input works as an OPEN input by default. This can be changed to a pedestrian input in programming. (see page 8 for instructions)

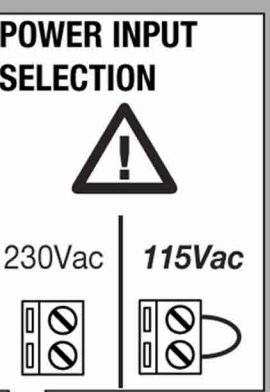

CP.B6-1024
Controller

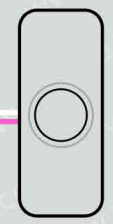
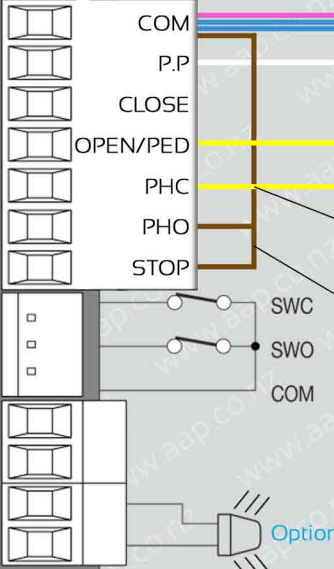
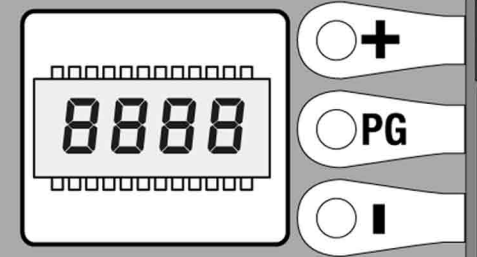

Remove link wire that is going from COM to PHC when using safety beams. The N/C & COM from the safety beam contacts replace this link

The controller also comes default with a link wire from PHO to COM & STOP to COM. Leave these loops connected for standard installations

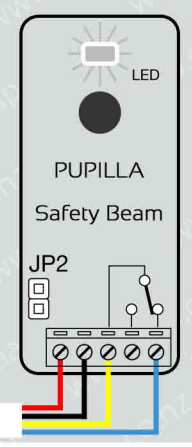
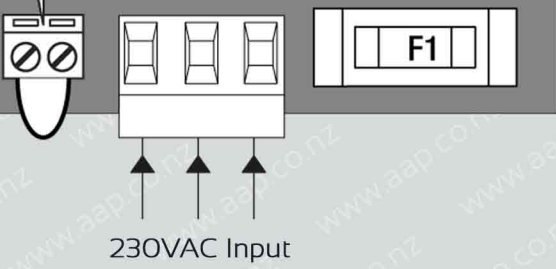

Note: Safety beams use **N/C & COM** terminals as shown here

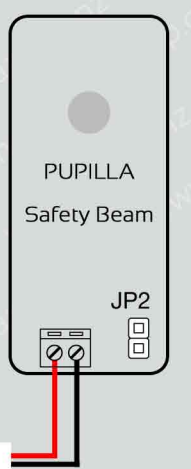

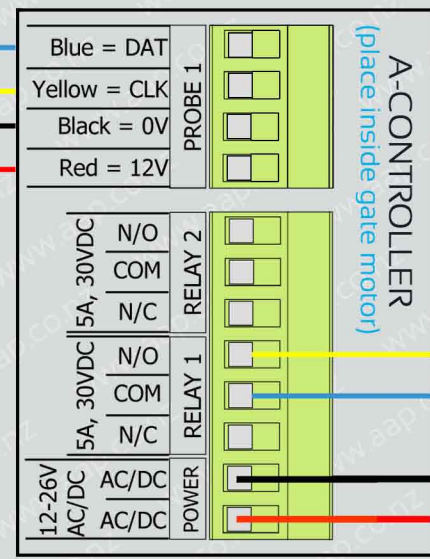

Note: When using the 'A-PROBE' the 'P.P.' input needs to be changed from default programming (see page 8 for instructions)



Use only the pink, white, red & black wires indicated for standard installations

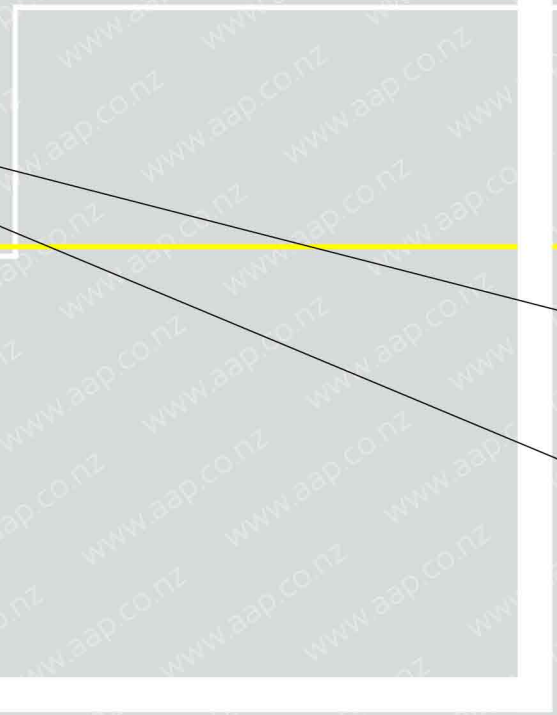
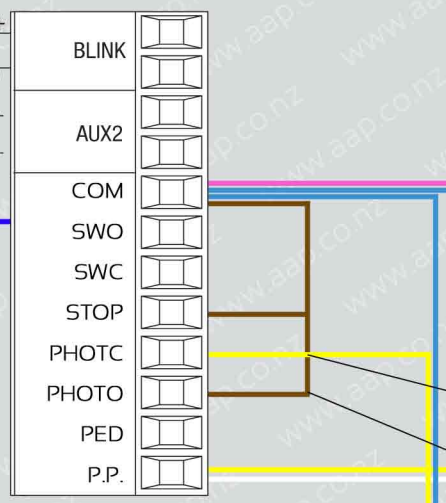
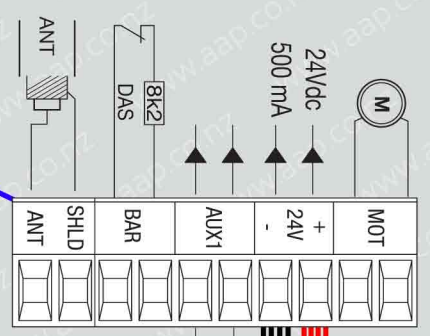
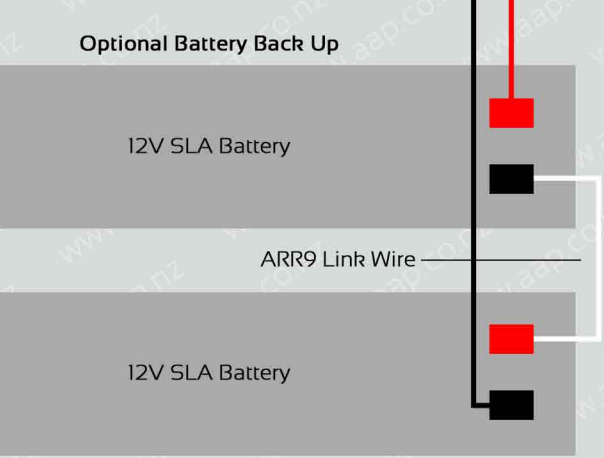
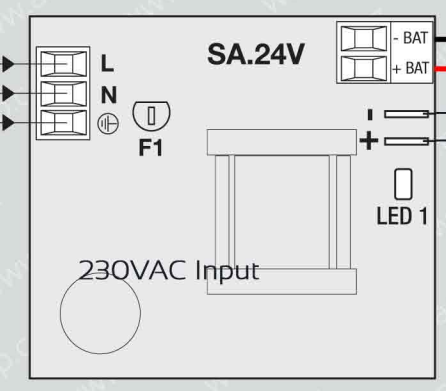
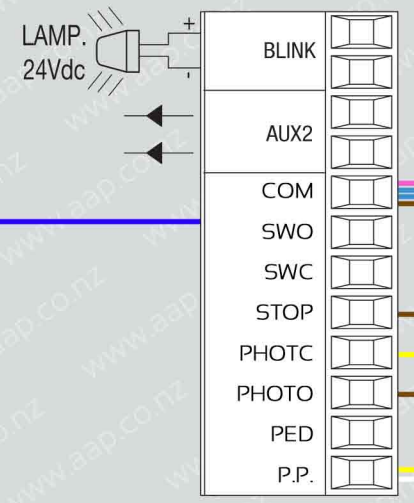
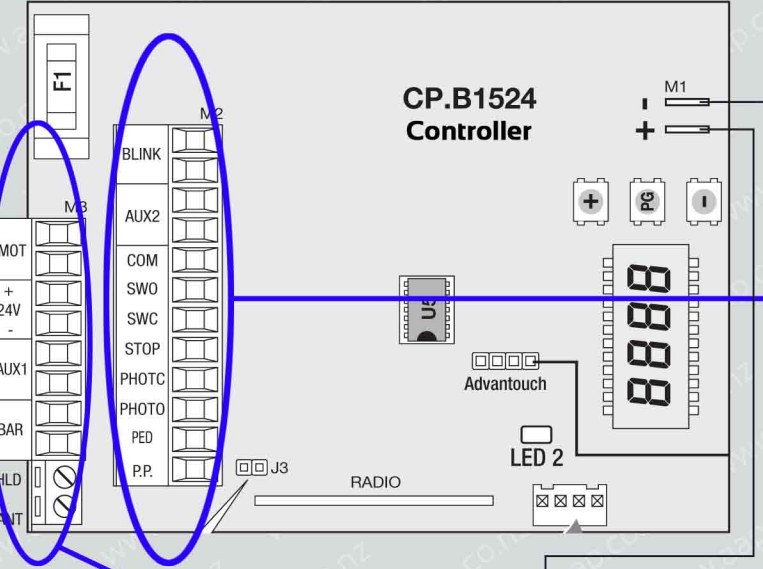

Remove link wire that is going from COM to PHC when using safety beams. The N/C & COM from the safety beam contacts replace this link

The controller also comes default with a link wire from PHO to COM & STOP to COM. Leave these loops connected for standard installations

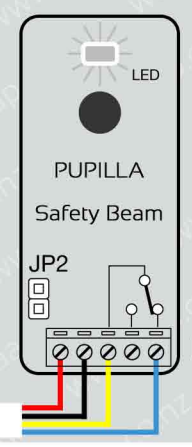
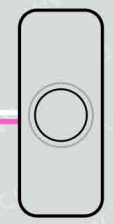

Note: Safety beams use N/C & COM terminals as shown here

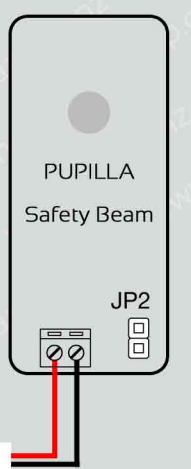

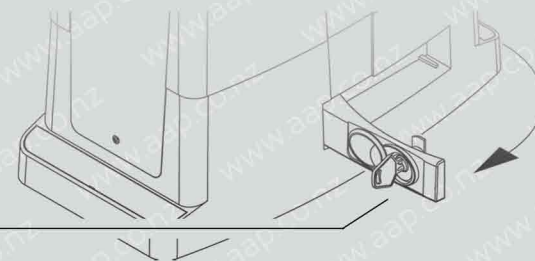

Pre Programming Hardware Set Up

- Unlock the motor/gear box by using the key and lever system shown here:
- Slide the gate until the spring limit switch on the motor is not hitting either the open or closed limit switch brackets which you have fixed to the nylon racking (detailed - page 3, item 3 of the cable schematic)
- Lock the motor/gear box and continue with the next step
- There should now be no 'dashes' on the display. If there are still 'dashes' on the display, check the ERROR messages detailed below to diagnose:

Fault finding before you program (See more ERROR messages in full manual on page 9)

- The controller display is designed to tell you what is wrong if something hasn't been wired correctly. You should have no vertical or horizontal 'dashes' on the display before you start programming. The only exception would be the SW Open or SW Close 'dashes' which would indicate the gate is in the fully open or fully closed position. Unlock the gear box lever and place the gate in the middle of its stroke (as explained above) & re lock

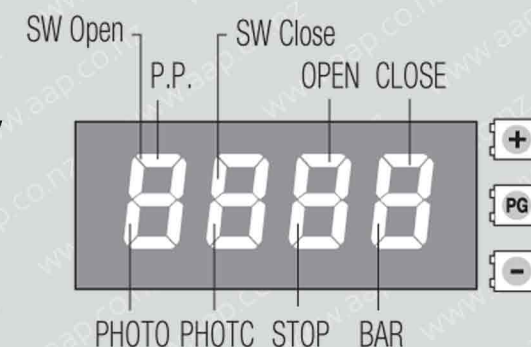

All **Beninca** products stocked by **Arrowhead Alarm Products** contain a digital display for simple programming

- There are three main menus which are accessed using the +, -, and 'PG' buttons. PG is used as an 'Enter' button, + & - are used for scrolling through the menus shown here
- Press the + & - together at the same time to take you back to the previous menu and repeat to return to the home screen or 'operating screen'

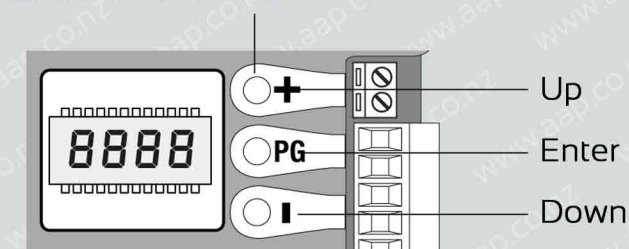

The main programming categories are as follows:

- **AUTO** - Automatically configuring the system (we would recommend starting with this and adjusting minor parameters later for a simple installation)
- **PAR** - Adjusting automatic closing time, the percentage of opening for the pedestrian input, opening speed, closing speed, torque & more
- **LOG** - Turning functions on/off, changing motor direction & changing controller input functions
- **RADI** - Learning wireless remotes &/or keypads
- **RES** - Restoring factory defaults. Note: This will not delete remotes from the system. To delete remotes, enter the RADI menu, scroll to cLr (to delete one remote) or rtr (to clear everything in the receiver) and push the PG button twice. See RADI section in the full manual for full details on how to delete remotes

You are now ready to program, see next page for instructions

Simple Programming

= From the home screen, press the PG button to display either of the following menus: AUto, PAr, LoG, rAd 1, rES, nNAn, NAc1, codE or bUS

- Scroll using the + or - buttons until the display reads AUtO
- Press the PG button again to access the 'autoset' function and the display should read 'PUSH'
- Make sure nothing is obstructing the safety beams
- Press the PG button again to start the autoset function

Your gate should start performing a series of open and closes which is part of the learn cycle. Normally the gate will close - open - close or vice versa during the learn cycle. When the learn cycle is finished the display should read 'OK' to indicate completion of the learn cycle

- **Push the + & -** together multiple times until you are out of programming. I.e. The + & - normally need to be pressed together 2 or 3 times to get back to the home screen
- **Now check that the gate is traveling the correct direction.** I.e. The system has a 40sec auto close by default, so if you activate the gate by shorting the PP terminal to common, (or by using the keypad or exit probe) the gate should auto close after 40 seconds, not auto open. See 'Changing Motor Direction' below if gate is travelling in the wrong direction

Changing Motor Direction (Only if your gate is travelling in the wrong direction)

- From the home screen, press the PG button, then press the + or - button until you get to LoG. Press the PG button to enter this menu, then press the + or - button until you get to NIru. Press the PG button, then press the + or - button until the display reads ON. Press the PG button to confirm and exit programming by pushing the + or - buttons at the same time as previously explained. **The system should now be configured**

Fine Tuning

- Should you wish to change any of the default functions you will perform the same procedure as above by using different programming address. See below for some examples:

Turn OFF Auto Close Function

- From the home screen, press the PG button, then press the + or - button until the display reads LOG. Press the PG button to enter this menu and the display will read TCA, (if not use the + or - button until the display reads TCA). Press the PG button to enter the TCA menu then press the + or - button to change the TCA function to OFF or ON. Press the PG button to confirm and exit programming by pressing the + & - buttons together multiple times until you are back to the home screen

See next page for more common programming examples

Display Example

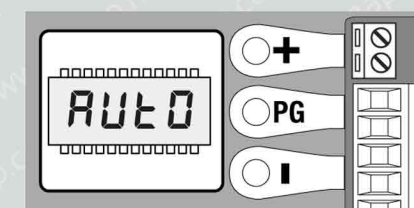

Changing Auto Close Time (make sure autoclose (tcA) is on as explained in the previous step)

- From the home screen press the PG button to enter the first menu. Use the + or - button to scroll until the display reads PAr
- Press the PG button again to enter the PAr menu and the display should read tcA (this is the parameter for auto close time)
- Press the PG button again to enter the tcA menu and the display should read the tcA time (default 40 seconds). Now press the + or - button to change auto close to the desired time, followed by the PG button to confirm. Press the + & - together several times to return to the home screen

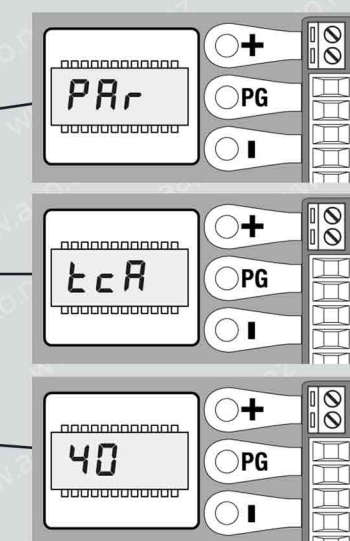

Changing P.P Input To Open Input (BULL1524 only) This is required if you are using an exit probe/loop or hold open function

- This is required when using **loop detectors or exit probes** to automatically open the gate when a vehicle is exiting the premises. If this is not changed from default the gate will not operate correctly when multiple vehicles are leaving at one time. The gate will open - close - open -close etc, and in this application you only want the gate to open when triggered multiple times

- From the home screen press the PG button to enter the first menu. Use the + or - button to scroll until the display reads LoG as follows:
- Press the PG button to enter the LoG menu, then use the + or - buttons to scroll to oPcL. This is where the P.P input is changed to open & PED input is changed to closed
- Press the PG button again to enter the oPcL menu and use the + or - button to turn this function ON or OFF. On means the P.P input is a dedicated open and OFF is the standard setting, similar to garage door functionality. Press the PG button to confirm your selection, then press the + or - buttons together several times to return to the home screen

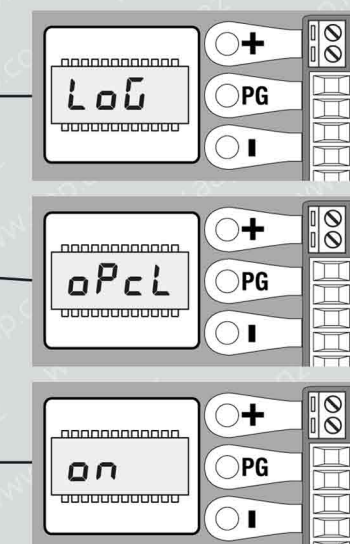

Learning Remotes

- From the home screen press the PG button to enter the first menu. Use the + or - button to scroll until the display reads rAd 1
- Press the PG button to enter the rAd 1 menu and the display should read PP
- Push the PG button again and the display should read PUSH. Now push the remote button you wish to learn and the display should read OK. Repeat to learn more remotes or press the + & - together several times to return to the home screen

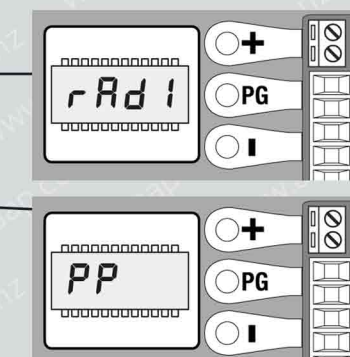

The following tables are directly from the full manual. Follow the same procedure as detailed above to change any of the functions and features the product has to offer. Don't be afraid of making a mistake as you can always use the rES (reset) option in the first menu to return the system to default settings



Input/Output Descriptions

M2 SEL. 115V	Mains power supply selection	230Vac 50/60Hz (from 207Vac to 253Vac) M2 OPEN jumper 115Vac 50/60Hz (from 102Vac to 125 Vac) M2 CLOSED jumper
L-N-GND	Mains power supply	Mains power supply input selectable via M2 jumper.
+ BATT -	Batteries	Input for connecting buffer batteries (accessory) 2x12V 2.1Ah
M11	Motor	24Vdc motor connection
+ 24 -	24 Vdc	Accessories power supply output 24Vdc 0.8 A max (respect accessories polarity).
AUX1	AUX 1 Auxiliary output	Output with N.O. contact configurable by AUX1 operating logic
BAR J3	Responsive sensor	Responsive sensor contact input Resistive sensor: Jumper "DAS" closed Mechanical sensor: Jumper "DAS" open The sensor stops the movement of the door and reverses it for about 3s. If the sensor is not used: Jumper "DAS" open, jumper between BAR terminals.
RELEASE SW.	Magnetic Sensor	Input for safety microswitch connected to the release lever. Motor stops IF RELEASE LEVER OPEN. All LED segments are on.
S.I.S.	Synchronisation card optional	Optional SIS card input for synchronising two opposing automations. See paragraph synchronisation of two automations.
BLINK	Flashing	24Vdc output 15W max. for connection to the flashing light.
AUX2	Auxiliary output AUX 2	24 Vdc output configurable by AUX2 operating logic (0.5A max)
COM	Common Inputs	Common for all control inputs.
SWO	Limit switch opens	Limit switch input OPENS (N.C. contact).
SWC	Limit switch closes	Limit switch input CLOSES (N.C. contact).
STOP	STOP	Button input STOP (N.C. contact).
PHO	Photocell opening/closing	Photocell input active in opening and closing (N.C. contact).
PHC	Photocell closing	Photocell input active only during closing (N.C. contact)
OPEN	Opens	Input for configurable opening command as pedestrian input (N.O. contact)
CLOSE	Closes	Close command input (N.O. contact)
PP	Step-by-step	Step-by-Step button input (N.O. contact)
COM	Common Inputs	Common for all control inputs.
ANT-SHIELD	Antenna	Built-in radio transmitter card antenna connection (ANT-signal/SHIELD-screen).

Error Messages

<i>Err 1</i>	Motor error	Verify the motor wirings, faulty motor or not connected, problem on the control unit.
<i>Err 2</i>	Photocell check error	
<i>Err 4</i>	SENSOR input error during Autoset	
<i>Err 5</i>	PHOT closing error	
<i>Err 6</i>	SENSOR error during Autoset	
<i>Err 7</i>	STOP input error during Autoset	
<i>Err 8</i>	INPUTS ACTIVATION (START/OPEN/CLOSE) error during Autoset	
<i>RNP</i>	Amperometric sensor intervention	Verify the presence of obstacles or friction points.
<i>Thrn</i>	Thermal sensor intervention	Overheating due to permanent obstacles. Unlock the gate and verify there are no points of friction.
<i>ouLd</i>	Overload	Exceeding of the maximum power. Verify the motor and presence of friction points..

8.4.1) PARAMETERS (PRr)			
MENU	FUNCTION	MIN-MAX-(Default)	MEMO
<i>t c R</i>	Automatic closing time. Enabled only with logic "TCA"=ON. At the end of the set time, the control unit commands a closing maneuver .	3-240-(40)	
<i>t P E d</i>	The passage left open by the gate leaf during the partial opening (pedestrian) is adjusted.	10-99-(50)	
<i>F S t o</i>	The opening speed is adjusted.	50-99-(99)	
<i>F S t c</i>	The closing speed is adjusted.	50-99-(99)	
<i>S l d o</i>	Adjusts the slowdown speed of sliding door during the opening phase* (Fig.10 -slow Open).	10-50-(25)	
<i>S l d c</i>	Adjusts the slowdown speed of sliding door during the closing phase * (Fig.11 -slow Close).	10-50-(25)	
<i>t S n o</i>	Sets the starting point of the slowdown during the opening phase (Fig.10- beginning of the slow Open). The value is expressed in percentage on the entire stroke.	1-99-(20)	
<i>t S n c</i>	Sets the starting point of the slowdown during the closing phase (Fig.11- beginning of the slow Close). The value is expressed in percentage on the entire stroke.	1-99-(20)	
<i>P n o</i>	Adjusts the motor torque applied to sliding door during the opening phase.*	1-99-(20)	
<i>P n c</i>	Adjusts the motor torque applied to sliding door during the closing phase.*	1-99-(20)	
<i>P S o</i>	Adjusts the motor torque applied to sliding door during the slowdown in opening phase * (Fig.9 - Slow Open).	1-99-(20)	
<i>P S c</i>	Adjusts the motor torque applied to sliding door during the slowdown in closing phase * (Fig.10 - Slow Close).	1-99-(20)	
<i>t L S</i>	Activation time of the courtesy light contact. Value expressed in seconds. At the beginning of each maneuver the contact latches for the set time. See the description of AUX1 parameter.	1-240 (60)	
<i>AUX 1</i>	It selects the operating mode of the AUX 1 output: 0: Open gate indicator light. The light is off when the door is closed, flashes with moving door and is on with open door. See wire diagram. 1: Second radio channel. The output is controlled by the radio channel of the built-in receiver (see RADIO Menu). 2: Service light. The contact closes for the time preset with TLS parameter. The countdown starts at the inception of operation. 3: Photo-test Used to power the photocell transmitters in TEST mode See wiring diagram Fig.23.	0-3-(1)	
<i>AUX 2</i>	Same operation features as AUX1 output, but referred to terminals AUX2. ATTENTION!: Max AUX2 output voltage is 24Vdc/0,5 A Max. You can directly power 24Vdc devices, as shown in Fig. 24.	0-3-(0)	

*** ATTENTION: A WRONG SETTING OF THESE PARAMETERS CAN BE DANGEROUS. RESPECT THE REGULATION IN FORCE!**
Measure that impact forces comply with the values laid down in regulation en 12445. change, if necessary, the operating parameters and repeat the measurements. Once you have manually modified the parameters sldo, sldc, pmo, pmc, pso, psc, the controller performs a complete manoeuvre to learn the new parameters and "PRG" appears on display.

8.4.2) LOGICS (L o U)			
MENU	FUNZIONE	ON-OFF-(Default)	MEMO
<i>t c R</i>	Enables or disables automatic closing On: automatic closing enabled Off: automatic closing disabled	(ON)	
<i>ibL</i>	Enables or disables condominium function. On: condominium function enabled. The step-by-step impulse or transmitter impulse has no effect during the opening phase. Off: condominium function disabled.	(OFF)	
<i>ibcR</i>	The multi-flat function is enabled or disabled during the TCA counting. On: the bloc of flat function is enabled. The Step-by-Step signal or the transmitter signal has no effect during the TCA counting. Off: the bloc of flat function is disabled.	(OFF)	
<i>S c L</i>	The rapid closure is enabled or disabled On: rapid closure is enabled. When the gate is open or moving, the photocell activation causes the automatic closure of the gate after 3 s. It is activated only with t c R:ON Off: rapid closure is disabled.	(OFF)	
<i>PP</i>	Selects the operating mode of the "Step by step button" and of the transmitter. On: Operation: OPEN > CLOSE > OPEN > Off: Operation: OPEN > STOP > CLOSE > STOP >	(OFF)	
<i>P r E</i>	Enables or disables pre-blinking. On: Pre-blinking enabled. Blinking is activated 3s before the motor starts. Off: Pre-blinking disabled.	(OFF)	



Parameters Continued

htr	Enabled or disables HOLD-TO-RUN function On: HOLD-TO-RUN function. The pressure of the OPENS/CLOSES button must be maintained throughout the entire manoeuvre. The opening of the STOP input stops the motor. All the safety inputs are deactivated. Off: Automatic/semiautomatic function	(OFF)	
LtcA	Selects the operating mode of the blinking light during the time TCA On: Blinking light on during TCA Off: Blinking light off during TCA	(OFF)	
PhcL	The operating mode of the PHOT C input is selected. On: PHOT C input is activated in both opening and closing phases. In the opening phase: the contact opening causes the motor stop. When the photocell is released, the motor restarts in the opening phase. In closing phase: the contact opening causes the motor stop. When the photocell is released, the motor inverts the movement direction (open). Off: The PHOT C input is activated in the closing phase only. In the closing phase: the contact opening causes the motor stop and the immediate reversion of the operation direction (open).	(OFF)	
oPcL	Enables OPEN input as Pedestrian input (Partial parameter TPED opening). On: OPEN input enabled as pedestrian input (PED). Off: No modification to the OPEN input	(OFF)	
tSt 1	Enables or disables checking of photocells on PHOT input, active both in closing and in opening. On: Check enabled. If the check has a negative result, no manoeuvre is commanded. See Fig.16 - "PHOTO TEST". (AUX1=3) Off: Check of photocells each time a manoeuvre is disabled. This setting requires maintenance of photocells every 6 months.	(OFF)	
tSt 2	Enables or disables the check of photocells on PHOT C input. On: Check enabled. If the check fails, no manoeuvre will be enabled. (AUX1=3) Off: Check of photocells each time a manoeuvre is disabled. This setting requires maintenance of photocells every 6 months.	(OFF)	
bAr	Changing the operating mode of the PHOT OPEN and BAR inputs in the event the sensitive edges are installed on the mobile opening and closure edges (see Fig.21). On: The PHOT OPEN input assumes a similar function to the BAR input, but inverts motion for 3s only during the opening phase. The edge connected to the BAR input is only active during the closure phase. Off: Intervention of the sensitive edge connected to the BAR input stops movement of the door and inverts for approx. 3s, both opening and closure. The PHOT OPEN input re-starts functioning of the photocell active on opening.	(OFF)	
RoPF	The "forced opening in case of power cut-off" function is activated or deactivated (it can be activated only with connected and operating emergency batteries). On: Activated function. In the event of power failure, before the emergency battery completely discharged, the control unit causes an opening operation. The barrier remains open until the power supply is back. Off: Deactivated function.	(OFF)	
n Inu	The opening direction of the motor is selected: On: Right side motor mount Off: Left side motor mount (fig.20)	(OFF)	
rEn	Enables or disables remote radiotransmitters learning, as indicated in the paragraph "Remote transmitters learning". On: Remote learning enabled. Off: Remote learning not enabled.	(ON)	

Remote & Wireless Keypad Learning

8.4.3) RADIO (r-Rd !)	
MENU	FUNZIONE
PP	By selecting this function, the receiver goes in waiting (PU5h) for a transmitter code to assign to the step-step function. Press the key of the transmitter to assign to this function. If the code is valid, it is memorised and the message oH is displayed If the code is not valid, the message Err is displayed
2ch	By selecting this function, the receiver goes into waiting (PU5h) for a transmitter code to assign to the second radio channel. Press the key of the transmitter to assign to this function. If the code is valid, it is memorised and the oH message is displayed If the code is not valid, the message Err is displayed.
PEd	When this function is selected, the receiver awaits (Push) a transmitter code to be assigned to the PED function. Press the transmitter key, which is to be assigned to this function. If the code is valid, it will be stored in memory and OK will be displayed. If the code is not valid, the Err message will be displayed.
nth	By selecting this function the LCD screen shows the number of transmitters memorized into the receiver.
clr	By selecting this function, the receiver goes into waiting (PU5h) for a transmitter code to erase from the memory. If the code is valid, it is erased and the message oH is displayed If the code is not valid or not present in memory, the message Err is displayed
rtr	Completely erases memory of the receiver. Confirmation of the operation is requested. By selecting this function the receiver goes into waiting (PU5h) for a new PGM pressure to confirm the operation. At end of erasing the oH message is displayed



8.4.4) CYCLES NUMBER (nPrn)

Displays the number of complete cycles (open+close) carried out by the automation.
When the <PG> button is pressed for the first time, it displays the first 4 figures, the second time it shows the last 4. Example <PG> 00 i2 >>> <PG> 3456: made 123.456 cycles.

8.4.5) MAINTENANCE CYCLES (PrC l)

This function enables to activate the maintenance request notice after a number of manoeuvres determined by the installer.
To activate and select the number of manoeuvres, proceed as follows:
Press button <PG>, the display will show OFF, which indicated that the function is disabled (default value).
With the buttons <+> and <-> select one of the numeric values proposed (from OFF to 100). The values are intended as hundreds of cycles of manoeuvres (for example: the value 50 indicates 5000 manoeuvres).
Press the OK button to activate the function. The display will show the message Pr oC.
The maintenance request is indicated to the user by keeping the indicator lamp lit up for other 10 sec after the conclusion of the opening or closing operation.

8.4.6) RESET (rE5)

RESET of the control unit. ATTENTION!: Returns the control unit to the default values.
Pressing the <PG> button for the first time causes blinking of the letters rE5, pressing the <PG> button again resets the control unit. Note: The transmitters are not erased from the receiver nor is the access password and the configuration of synchronism.
All the logics and all the parameters are brought back to default values, it is therefore necessary to repeat the autosect procedure.

8.4.7) AUTOSET (RUt o)

This function sets the optimal functioning values of the installation, at the end of the procedure, it sets the average values of torque (PMO/PMC and PSO/PSC). To carry out the AUTOSET, proceed as follow:
a) Make sure that during the autosect there is no obstacle in the maneuver area, if necessary, fence off the area so that persons, animals, cars, etc., cannot interrupt the procedure.
During the autosect phase, the anti-crushing function is not active, while the activation of inputs and safety devices generates an error. (paragraph 8.10)
b) select the function AUTO and press PG.
c) the control unit waits the confirmation to start the procedure "AUTO" FLASHING.
d) press PG to start the AUTOSET procedure.
The control unit performs few maneuvers for the stroke learning and the configuration of the parameters.
In case that the procedure is not successful the message ERR will be shown. Repeat the procedure after checking the wirings and the possible presence of obstacles.

8.4.8) PASSWORD (codE)

It allows to type in an access protection code to the programming of the control unit.
A four-character alphanumeric code can be typed in by using the numbers from 0 to 9 and the letters A-B-C-D-E-F.
The default value is 0000 (four zeros) and shows the absence of a protection code.
While typing in the code, this operation can be cancelled at any moment by pressing keys + and - simultaneously. Once the password is typed in, it is possible to act on the control unit by entering and exiting the programming mode for around 10 minutes in order to allow adjustments and tests on functions.
By replacing the 0000 code with any other code, the protection of the control unit is enabled, thus preventing the access to any other menu. If a protection code is to be typed in, proceed as follows:
- select the Code menu and press OK.
- the code 0000 is shown, also in the case a protection code has been previously typed in.
- the value of the flashing character can be changed with keys + and -.
- press OK to confirm the flashing character, then confirm the following one.
- after typing in the 4 characters, a confirmation message "CONF" appears.
- after a few seconds, the code 0000 appears again
- the previously stored protection code must be reconfirmed in order to avoid any accidental typing in.
If the code corresponds to the previous one, a confirmation message "oH" appears.
The control unit automatically exits the programming phase. To gain access to the Menus again, the stored protection code must be typed in.
IMPORTANT: TAKE NOTE of the protection code and KEEP IT IN A SAFE PLACE for future maintenance operations.
To remove a code from a protected control unit it is necessary to enter into programming with the password and bring the code back to the 0000 default value.
IF YOU LOOSE THE CODE, PLEASE CONTACT THE AUTHORISED SERVICE CENTER FOR THE TOTAL RESET OF THE CONTROL UNIT.

8.4.9) SYNCHRONIZATION (bU5)

MENU	FUNZIONE
<i>id</i>	Sets the synchronizing number. It is possible to set a numeric value from 0 to 16. If the ID parameter is to 0 the control unit is set as MASTER, all the other values set the barrier as SLAVE.
<i>Loc</i>	Allows a barrier set as SLAVE to receive local commands. See paragraph 8.5 "SYNCHRONIZATION OF TWO OPPOSITE SLIDING DOORS"

